



Sealco Commercial Vehicle Products

602-253-1007

fax 800/222-2334

www.sealcovp.com

NO.	DESCRIPTION
1.	SEALCO NO. 110800 SPRING BRAKE CONTROL VALVE
2.	WABCO NO. 480 107 000 RSS PLUS ECU ASSEMBLY
3.	WABCO NO. 400 500 103 0 ECU PREMIUM ASSEMBLY
4.	SEALCO NO. 110410 RELAY VALVE
5.	SEALCO NO. 110570 CONTROL LINE VALVE
6.	SEALCO NO. 10200-1/2 ONE-WAY CHECK VALVE
7.	SEALCO NO. 780115 FREE WHEEL CONTROL VALVE FOR LIFT AXLE
8.	SEALCO NO. 780215 FREE WHEEL CONTROL VALVE FOR LIFT AXLE
9.	SEALCO NO. 140270 PRESSURE PROTECTION VALVE
10.	WABCO NO. 432 500 005 0 CONTROL LINE FILTER
11.	SEALCO NO. 2550 LINE FILTER
12.	LIFT BAG
13.	RESERVOIR - VOLUME TO BE AS PER FMVSS-121
14.	SPRING BRAKE & SERVICE BRAKE CHAMBER

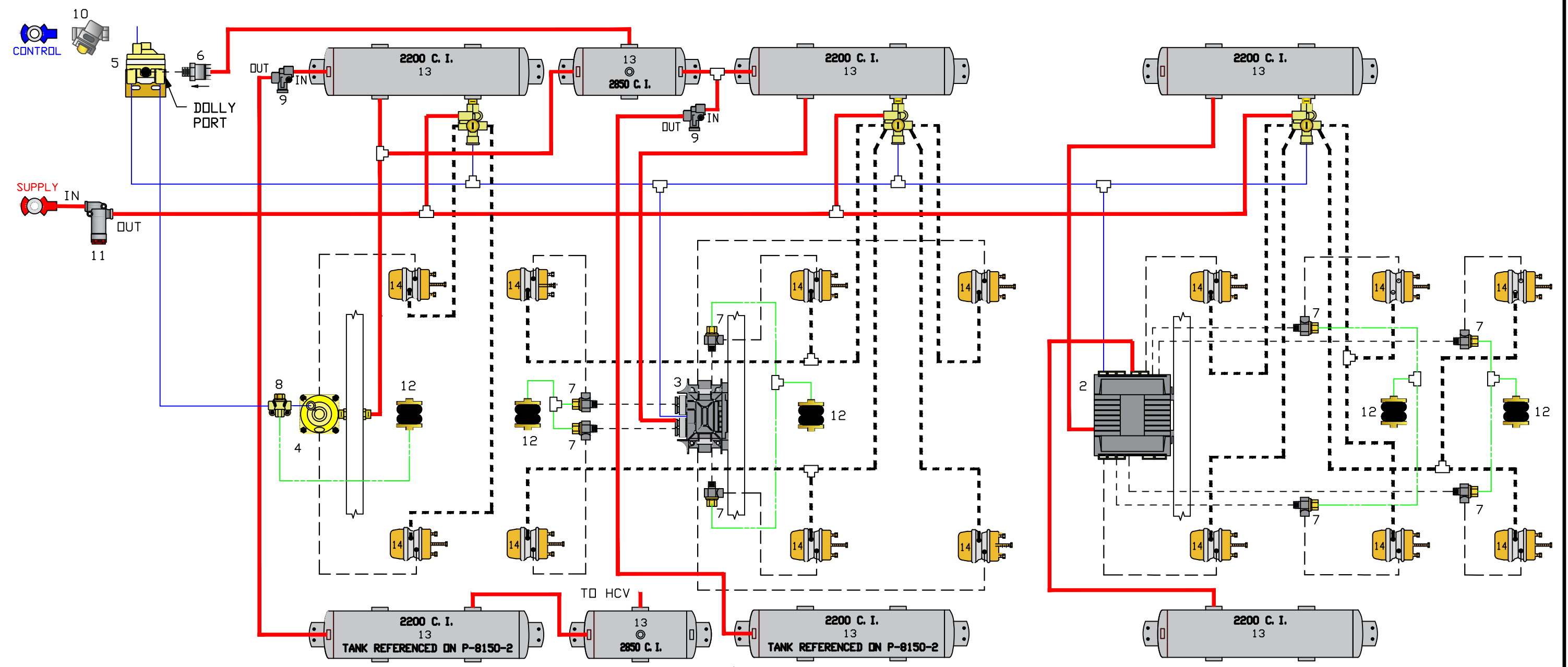
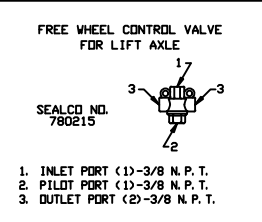
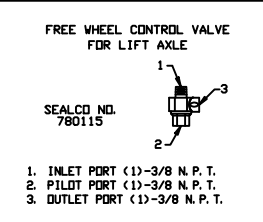
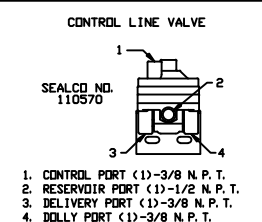
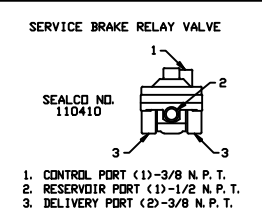
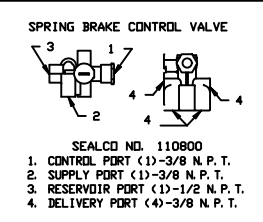
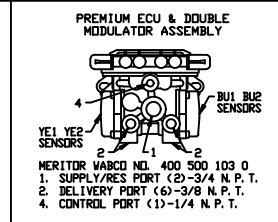
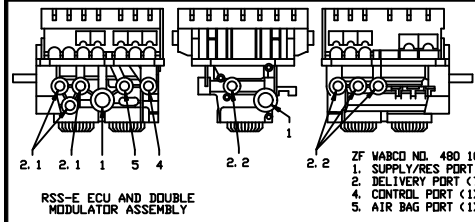

VEHICLE COMPLIANCE & CERTIFICATION WITH ALL APPLICABLE FEDERAL, STATE & PROVINCIAL REGULATIONS INCLUDING FMVSS 121 AND CMVSS 121 IS SOLELY THE RESPONSIBILITY OF THE VEHICLE MANUFACTURER

AIR SYSTEM DIAGRAM REQUESTED BY: \_\_\_\_\_

— CONTROL LINE (BLUE-3/8")  
 — SUPPLY LINE (RED-1/2")  
 - - - LIFT BAG  
 ···· RIDE BAG  
 - - - A/C ANTI COMPOUNDING  
 - - - PLUG ALL UNUSED PORTS

7 AXLE TRAILER W/ 5 LIFT AXLES BRAKE SYSTEM ONLY			
DR: MG	CH: ZY	DATE: 12-7-2023	JOB NO: P-8150-1