



Sealco Commercial Vehicle Products

602-253-1007

fax 800/222-2334

www.sealcovp.com

NO.	DESCRIPTION
1.	SEALCO NO. 110800 SPRING BRAKE CONTROL VALVE
2.	WABCO NO. 400 500 420 0 iABS
3.	SEALCO NO. 110415 RELAY VALVE
4.	SEALCO NO. 110410 / 110412 RELAY VALVE
5.	SEALCO NO. 110570 DOLLY CONTROL LINE VALVE
6.	SEALCO NO. 110580 CONTROL LINE VALVE
7.	SEALCO NO. 10200-1/2 ONE-WAY CHECK VALVE
8.	SEALCO NO. 140270 PRESSURE PROTECTION VALVE
9.	SEALCO NO. 200001 QUICK RELEASE VALVE
10.	SEALCO NO. 780115 FREE WHEEL LIFT VALVE FOR LIFT AXLE
11.	SEALCO NO. 780215 FREE WHEEL LIFT VALVE FOR LIFT AXLE
12.	WABCO NO. 432 500 005 0 CONTROL LINE FILTER
13.	SEALCO NO. 2550 LINE FILTER
14.	RESERVOIR - VOLUME TO BE AS PER FMVSS-121
15.	SPRING BRAKE & SERVICE BRAKE CHAMBER
16.	SEALCO NO. 6002 1/2 X 1/2 DR 6003 1/2 X 3/4 NIPPLE
17.	SEALCO NO. 616 1/2 X 3/4 DR 6006 3/4 X 3/4 NIPPLE

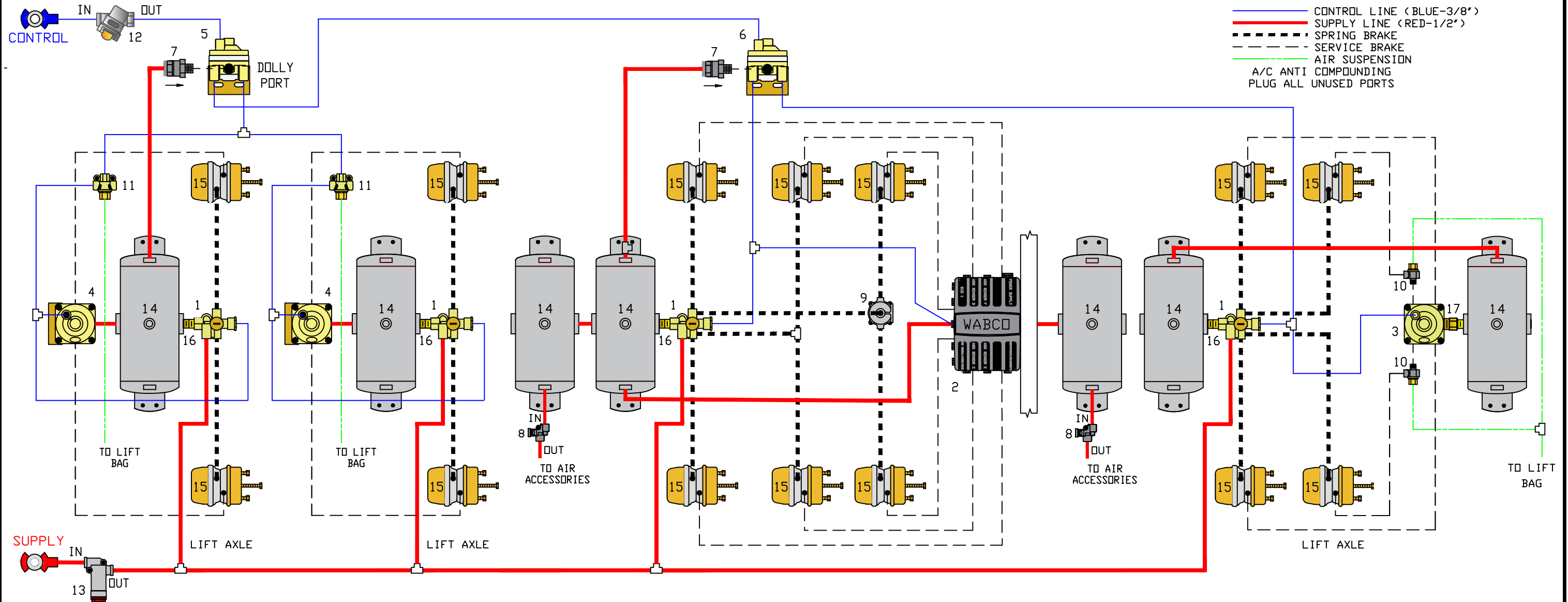
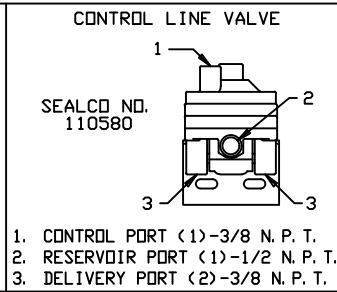
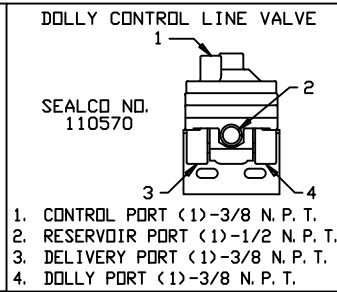
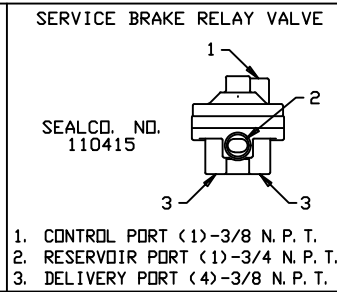
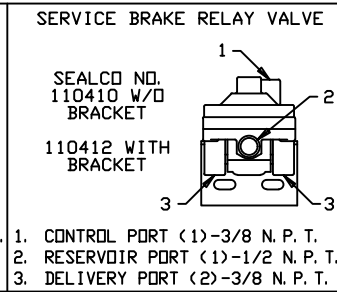
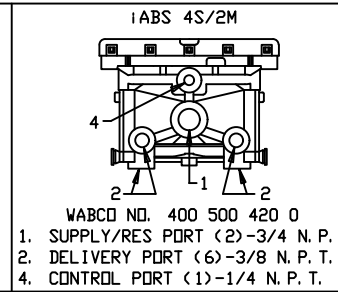
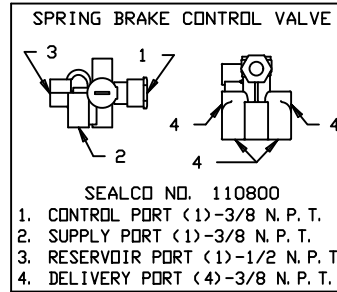

VEHICLE COMPLIANCE & CERTIFICATION WITH ALL APPLICABLE FEDERAL, STATE & PROVINCIAL REGULATIONS INCLUDING FMVSS 121 AND CMVSS 121 IS SOLELY THE RESPONSIBILITY OF THE VEHICLE MANUFACTURER

AIR SYSTEM DIAGRAM REQUESTED BY: _____

SEVEN AXLE 'TROMBONE' TRAILER

DR: MG	CH: ZY	DATE: 11-1-2022	JOB NO: P-8057
--------	--------	-----------------	----------------