

NO	DESCRIPTION	NO	DESCRIPTION
1	SEALCO NO. 110800 SPRING BRAKE CONTROL VALVE	11	SEALCO NO. 521160 5/2 VALVE MANUALLY OPERATED W/ BOOT
2	WABCO NO. 400 500 103 0 PREMIUM ECU VALVE ASSEMBLY	12	SEALCO NO. 780115 FREE WHEEL CONTROL VALVE - LIFT AXLE
3	WABCO NO. 472 195 033 0 ABS RELAY VALVE	13	LEVELING VALVE
4	SEALCO NO. 110580 CONTROL LINE VALVE	14	RESERVOIR - VOLUME TO BE AS PER FMVSS 121
5	SEALCO NO. 10200-1/2 ONE WAY CHECK VALVE	15	SPRING BRAKE & SERVICE BRAKE CHAMBER
6	SEALCO NO. 2550 LINE FILTER	16	616 1/2" X 3/4" NIPPLE OR 6002 1/2" X 1/2" NIPPLE
7	WABCO NO.432 500 005 0 CONTROL LINE FILTER	17	616 1/2" X 3/4" NIPPLE OR 6006 1/2" X 3/4" NIPPLE
8	SEALCO NO. 140270 PRESSURE PROTECTION VALVE		
9	SEALCO NO. 200001 QUICK RELEASE VALVE		
10	SEALCO NO. 321160 3/2 VALVE MANUALLY OPERATED W/ BOOT		

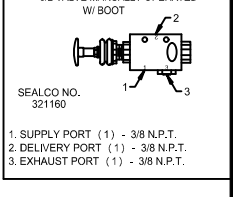
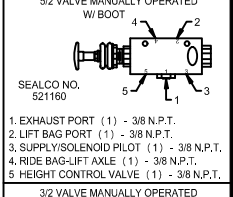
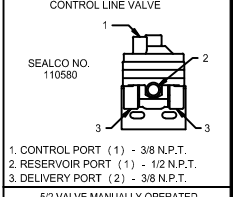
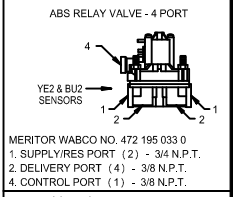
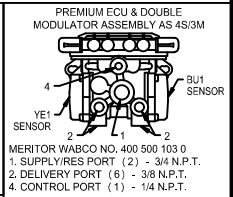
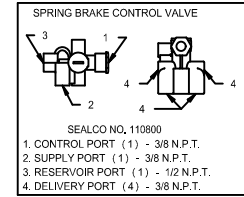
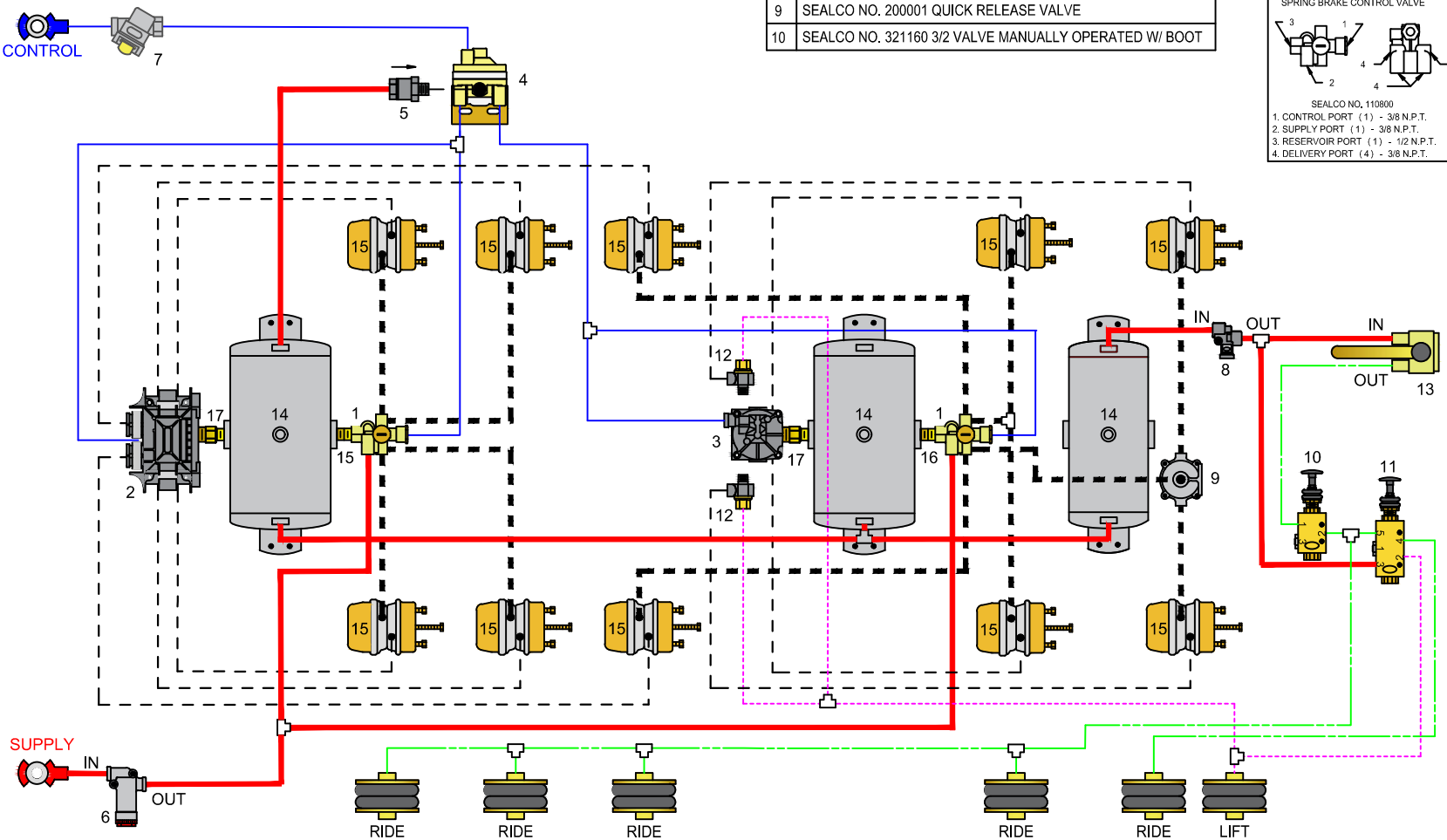

VEHICLE COMPLIANCE & CERTIFICATION WITH ALL APPLICABLE FEDERAL, STATE & PROVINCIAL REGULATIONS INCLUDING FMVSS 121 & CMVSS 121 IS SOLELY THE RESPONSIBILITY OF THE VEHICLE MANUFACTURER

AIR SYSTEM REQUESTED BY:

FIVE AXLE TRAILER WITH 1 LIFT AXLE AND 4S/3M ABS

DRAWN BY: MG	CHECKED: --	DATE: 3-8-2022	DRAWING NO: P-8000
-----------------	----------------	-------------------	-----------------------